

Applying Machine Learning Techniques in National Instruments' LabView to Identify NMR Signals

Connor McClain, Dustin Keller - University of Virginia

October 29, 2020

Overview

- ▶ NMR Detection with a Q-Meter

Overview

- ▶ NMR Detection with a Q-Meter
- ▶ Instrumental Limitations

Overview

- ▶ NMR Detection with a Q-Meter
- ▶ Instrumental Limitations
- ▶ Operational Improvements with the implementation of an Artificial Neural Network

Overview

- ▶ NMR Detection with a Q-Meter
- ▶ Instrumental Limitations
- ▶ Operational Improvements with the implementation of an Artificial Neural Network
- ▶ Results

Overview

- ▶ NMR Detection with a Q-Meter
- ▶ Instrumental Limitations
- ▶ Operational Improvements with the implementation of an Artificial Neural Network
- ▶ Results
- ▶ Conclusion and Future Work

NMR Signals

...spin structure and spin degrees of freedom

- ▶ Polarized targets allow the study of nucleon spin structure
- ▶ Measuring polarization requires the use of phase-sensitive NMR detectors
- ▶ We can extract information from both vector-polarized and tensor-polarized targets

Measuring polarization in scattering experiments requires a non-destructive continuous wave phase-sensitive detector (Q-meter based NMR)

Laboratory Systems

Dynamic Nuclear Polarization uses low temperature, high magnetic fields and microwave to transfer spin polarization from electrons to nuclei

- ▶ Dynamic Nuclear Polarization is used to polarize target
- ▶ NMR Systems from the Q-Meter used in polarized target experiments across the world

DNP Polarized Target Setup

UVA-LANL: Three completely new NMRs



UVA: Design

○ Insert



UVA: Tune System and Automation

○ NMR



○ Microwave



○ Target material

UVA: Target Insert with longest cell at 8 cm for 5T

œrlikon ○ Pumps

14,000 providing the highest cooling power for 1K system

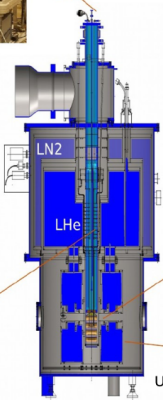

○ Fridge

UVA: Configure Fridge and Insert, Commission for Optimal running, setup with Actuator

○ Magnet

UVA: Commissioning, Slow Controls, Quench Study, Beamline interface,...



DNP Polarized Target Setup

- ▶ Zulkaida Akbar: The Polarized-Target System for the SpinQuest Experiment at Fermilab (2:24-2:36PM)

Q-Meter

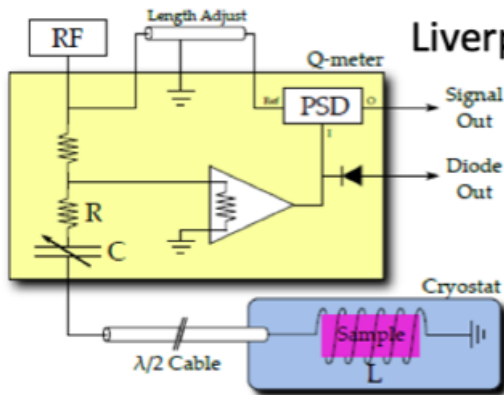

Liverpool Q-Meter

Q-Meter

with with

- ▶ Couples to magnetic susceptibility of target material
- ▶ Continues wave NMR with with tuning range of $1-7\lambda/2$
- ▶ Frequency range of 3-300 MHz
- ▶ Phase Sensitive
- ▶ Constant current, non-destructive polarization measurements

Example Experiment Setup

FNAL SpinQuest Experiment

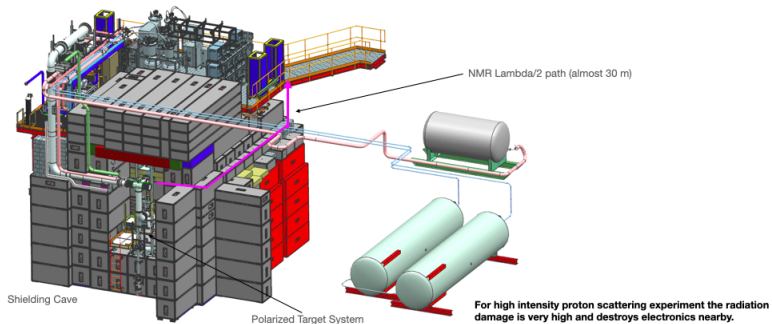

make as big as you can

Deuteron Signal

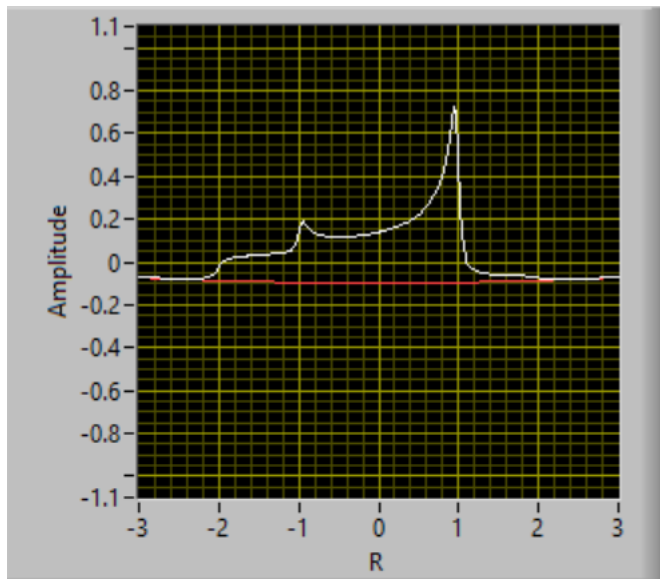
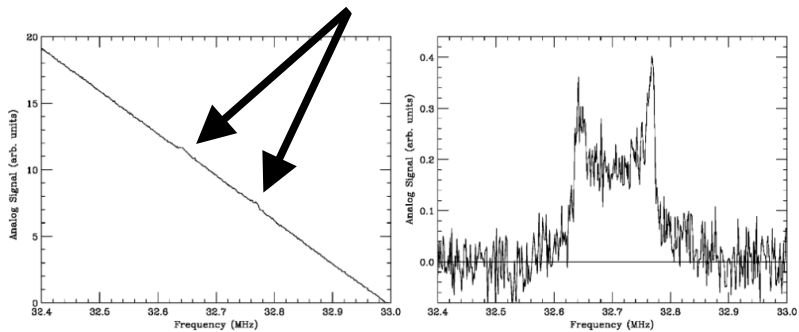

Figure: Deuteron Lineshape at 0.8 Polarization

Deuteron Signal



Deuteron Signal

Specifically for the Deuteron the magnitude and lineshape are sensitive to the polarization, so its a good candidate for pattern recognition studies

Within the theoretical framework, the polarization of the deuteron is the integral over all space of the signal we receive, so using Riemann Sum methods, we can calculate the polarization for a given signal.

Polarization Calculation

Here we can calculate the Riemann sum of the signal in LabView to acquire the polarization level of the deuteron.

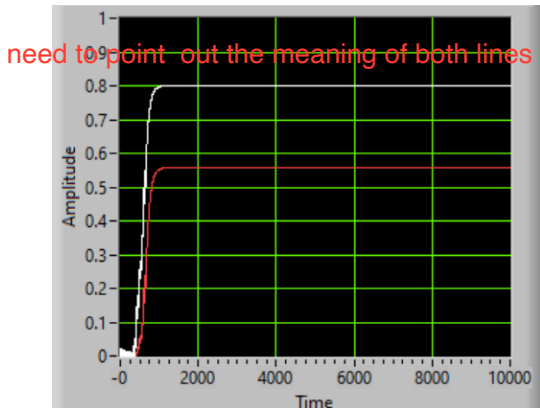

Figure: Reimman Sum Calculation for a Deuteron at 0.8 Polarization

Q-Meter Simulation

How do we get the deuteron signal from the Q-Meter? The Q-Meter scans over a range of frequencies, passing over the resonant frequency where the signal occurs.

Q-Meter Simulation

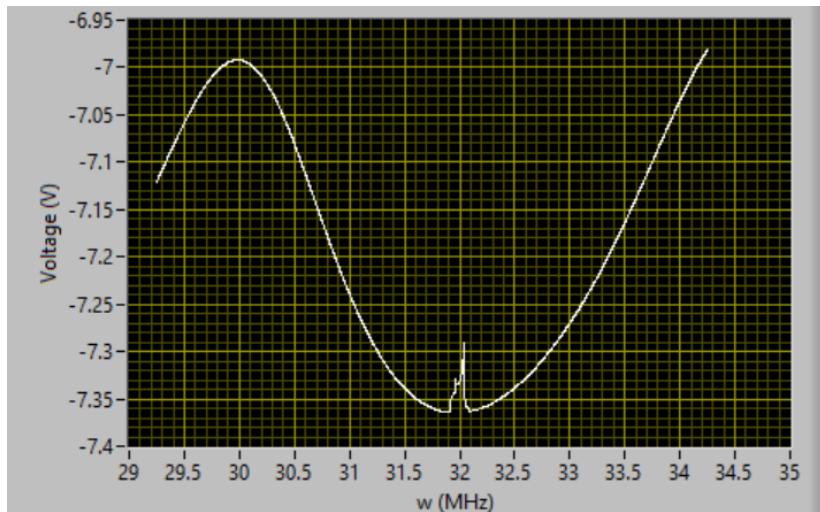

Figure: Deuteron Signal from the Q-Meter scanning over a large frequency range

Q-Meter

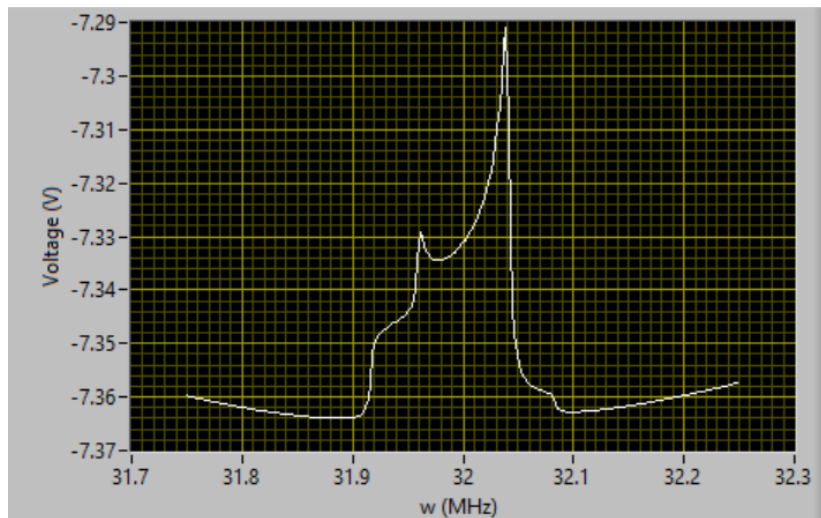

Figure: Deuteron Signal from the Q-Meter scanning around the resonant frequency

Background Noise

In order to make our simulation a viable approximation of the laboratory, we need to incorporate variables such as noise and $\lambda/2$ length.

Background Noise

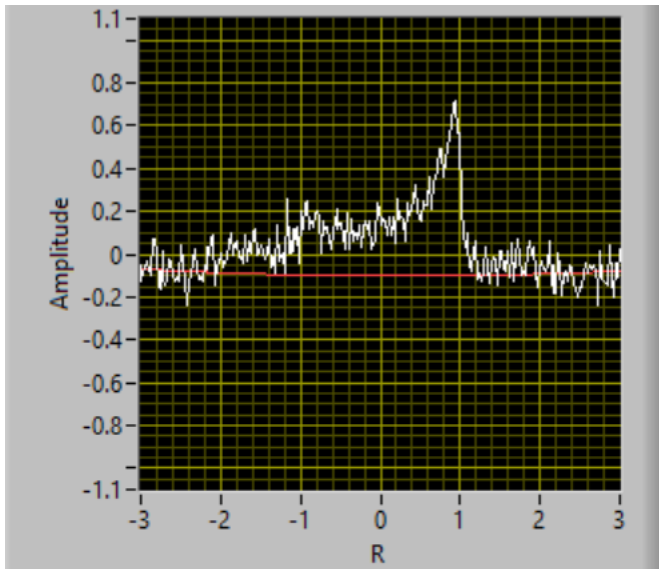
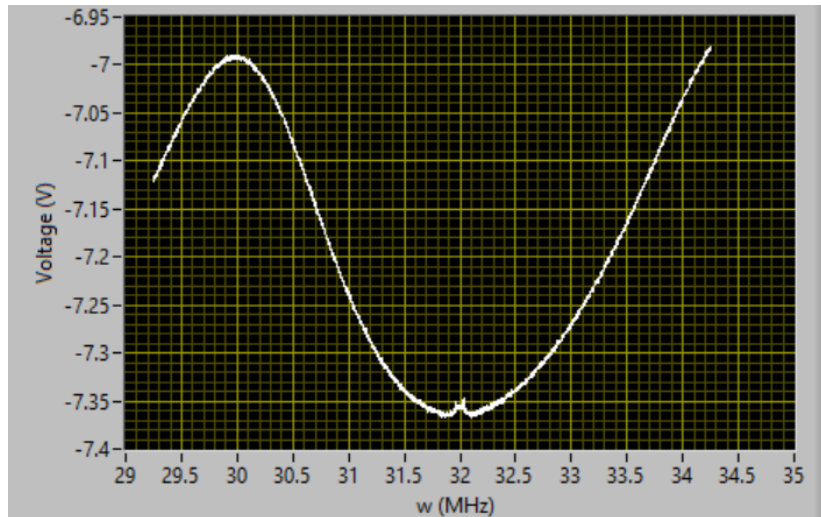
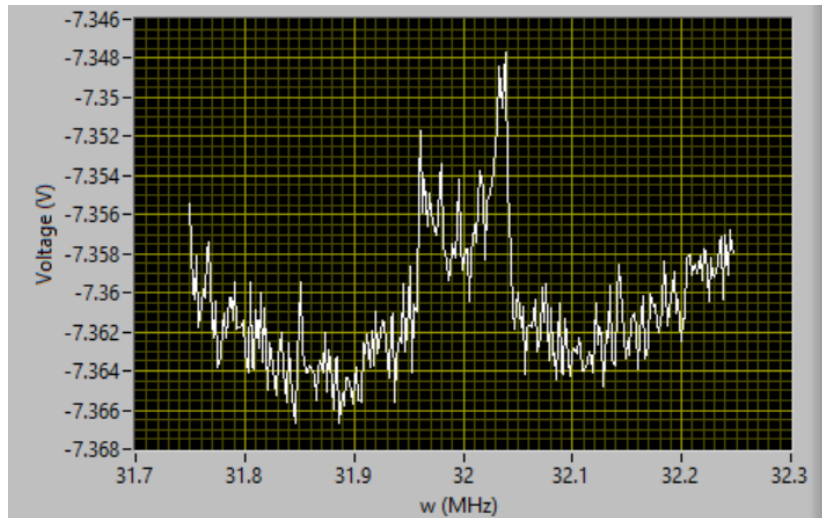

Figure: Deuteron Lineshape with Simulated Gaussian Noise

Background Noise in the Q-Meter Sim



Background Noise in the Q-Meter Sim



Why Neural Networks?

- ▶ Once we incorporate background noise Riemann sum methods can no longer be used
- ▶ There must be some unknown function that can account for both background noise and $\lambda/2$ length

Why Neural Networks?

- ▶ Multilayer Feedforward Networks with as few as one hidden layers and arbitrary squashing functions are universal approximators (Hornik, Stinchcombe and White, 1989).
- ▶ As long as we incorporate at least one hidden layer with a non-linear activation, we can approximate our unknown function.

Signal Processing Structure

can we have picture below and make bigger



Figure: Overview of Signal Processing

Neural Network Construction

- ▶ Goal: Create an effective network to calculate polarization while minimizing computational resources
- ▶ Used K-Fold Validation to test different network structures

Filtering a basic lineshape

For the task of filtering a basic lineshape, the network only required one hidden layer.

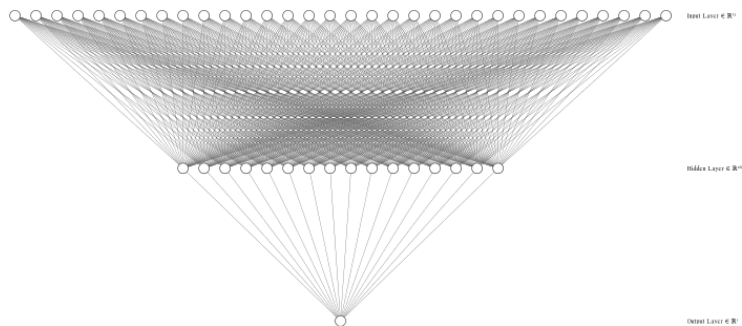

Figure: Structure for basic lineshape

Filtering a Basic Lineshape

If we add a reasonable amount of noise to our basic deuteron lineshape, we can use the neural network to easily extract the true polarization.

Filtering a Basic Lineshape

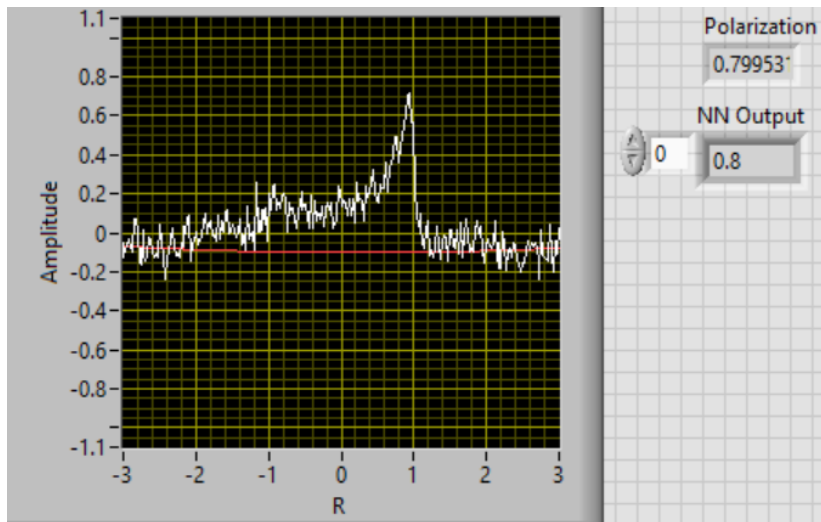

Figure: True polarization value and Network Output for a noisy simple lineshape

Filtering a Basic Lineshape

We can then use the output of the neural network to reproduce the analytical lineshape, thus filtering out the environmental noise.

Filtering a Basic Lineshape

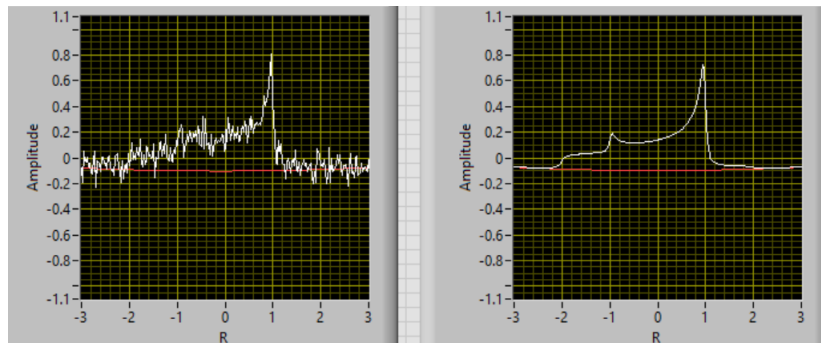
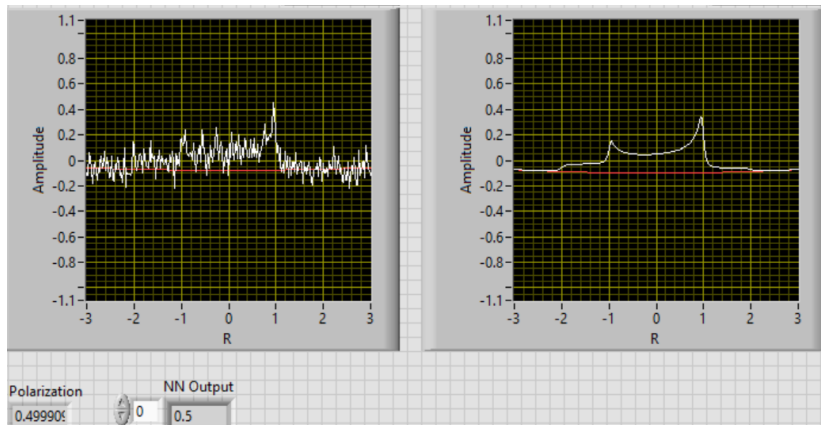

Figure: Signal filtered by a neural network

Filtering a Basic Lineshape

The network can filter signals that have a high noise to amplitude ratio.



Filtering a Basic Lineshape

At low polarization's and higher noise the network loses significant accuracy

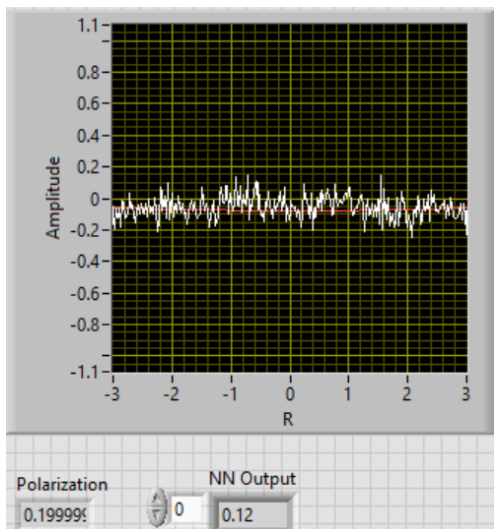

Filtering a Basic Lineshape

Its better to make quantitative states rather than qualitative

- ▶ The simple neural network is accurate at values which are within reason
- ▶ It is unreasonable to expect any network would be able to find a global fit and accurately determine all extreme values
- ▶ With enough training a network could adapt to all extrema, but it would overfit to the training data and would not extrapolate to the lab

Filtering Signals from the Q-Meter

In order to account for a fluctuating baseline and changes in the length of the $\lambda/2$ cable, this network must be more complicated.

Filtering Signals from the Q-Meter

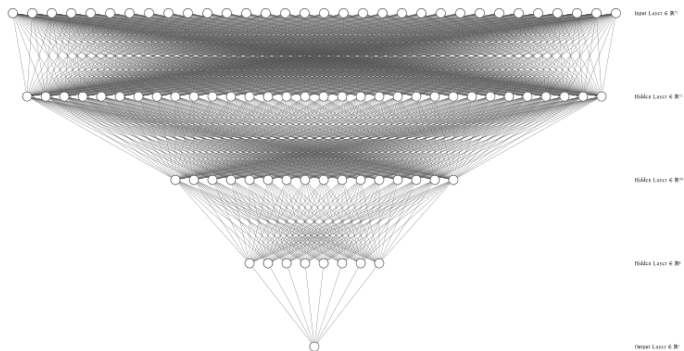

Filtering Signals from the Q-Meter

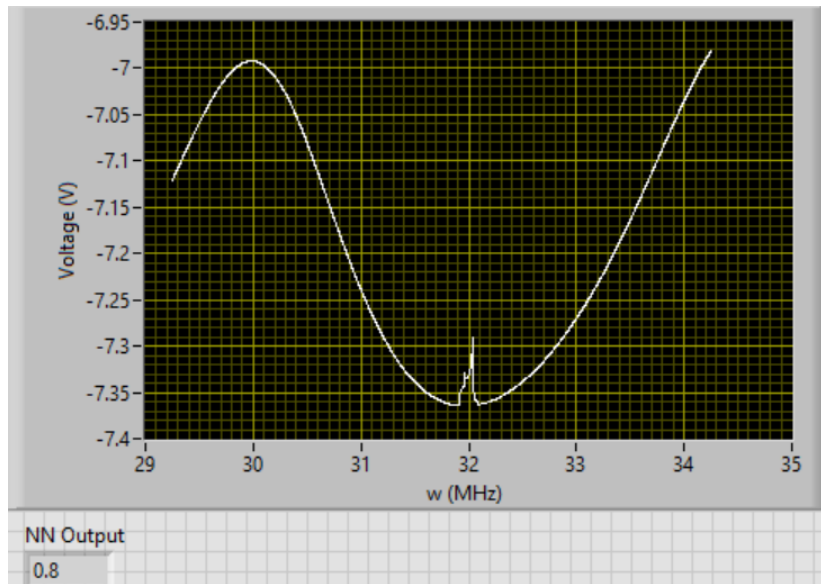

Deuteron at 0.8 Polarization with no noise

Filtering Signals from the Q-Meter

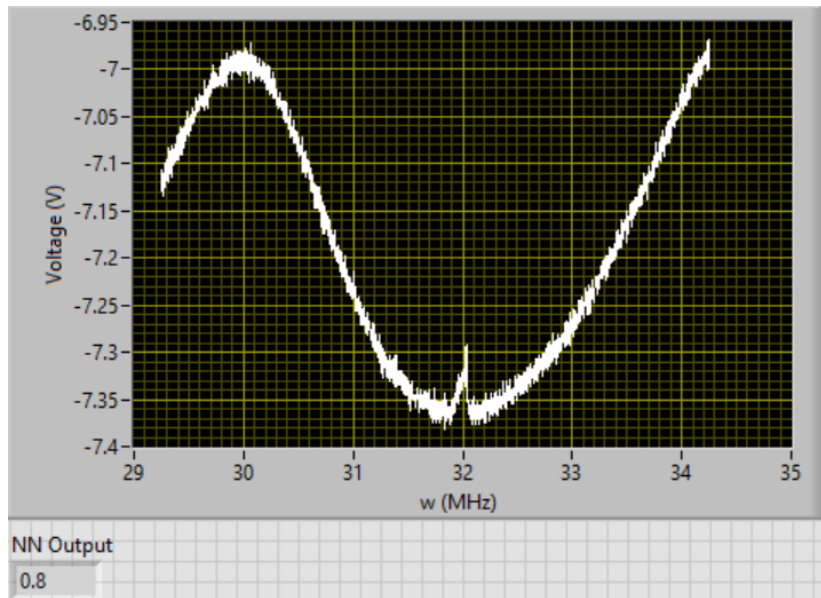

Deuteron at 0.8 Polarization with 5% noise

Filtering Signals from the Q-Meter

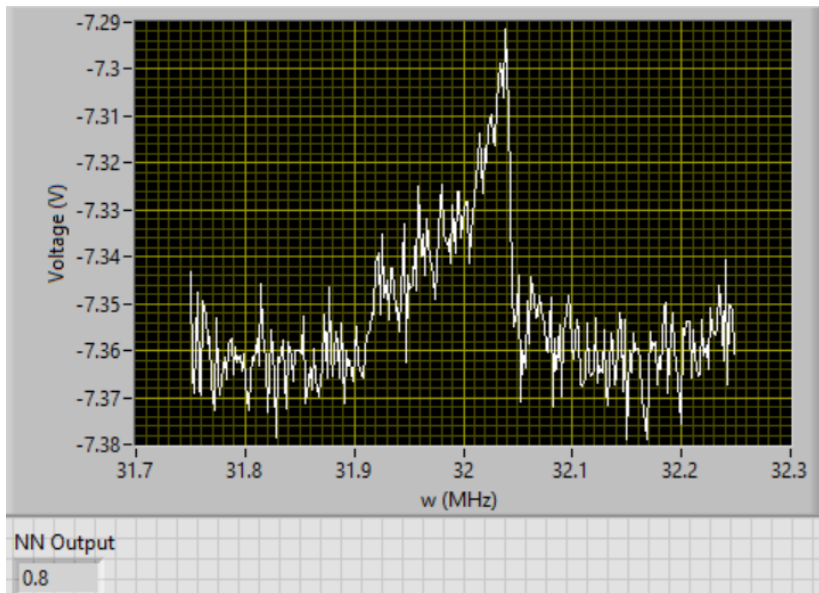

Deuteron at 0.8 Polarization with 5% noise (small range)

Filtering Signals from the Q-Meter

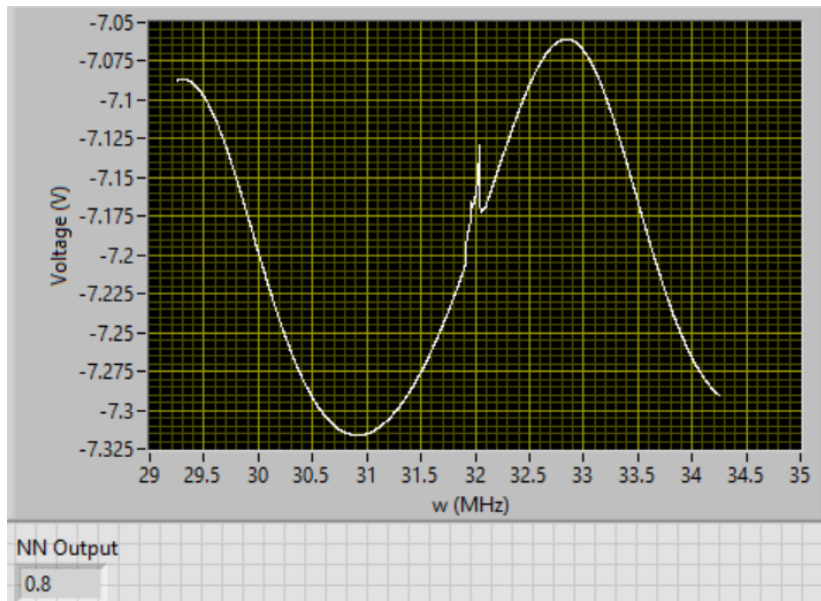

Deuteron at 0.8 Polarization with $9\lambda/2$ cable length

Filtering Signals from the Q-Meter

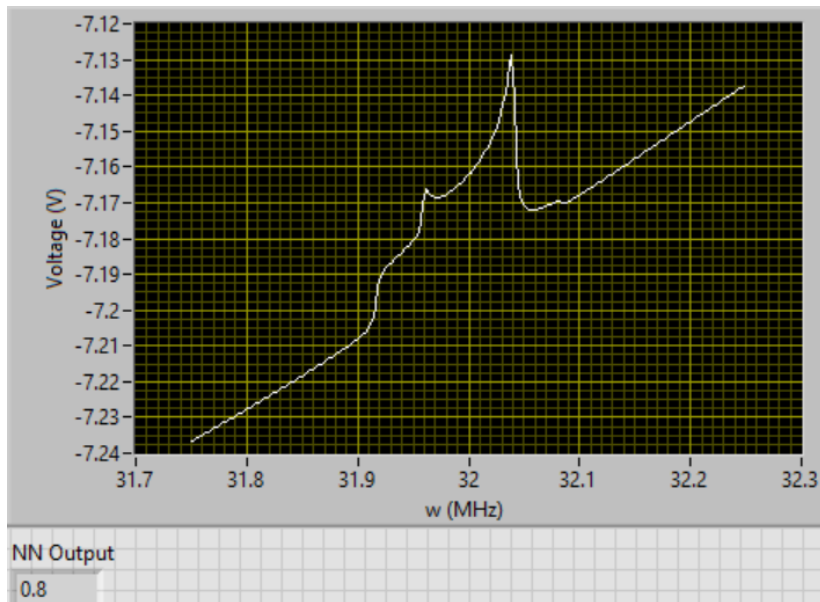

Deuteron at 0.8 Polarization with $9\lambda/2$ cable length (small range)

Filtering Signals from the Q-Meter

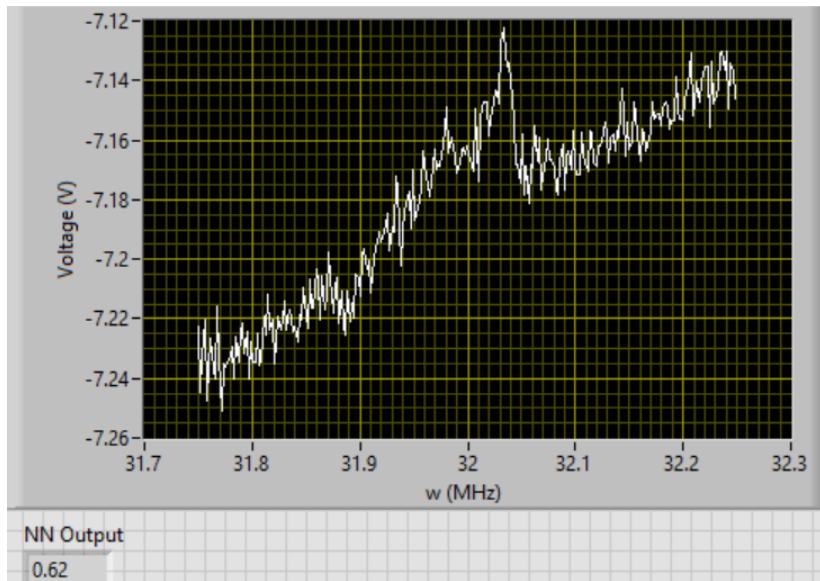

Figure: Deuteron at 0.8 Polarization with 5% noise and $9\lambda/2$ cable length

Conclusions

- ▶ Neural networks can efficiently be used to filter background noise from deuteron signals.

Conclusions

- ▶ Neural networks can efficiently be used to filter background noise from deuteron signals.
- ▶ Neural networks can adapt to changes in the baseline and scanning range of the signal.

Conclusions

- ▶ Neural networks can efficiently be used to filter background noise from deuteron signals.
- ▶ Neural networks can adapt to changes in the baseline and scanning range of the signal.
- ▶ Neural networks can adapt to changes in parameters which are outside the operational parameters of the physical systems.

What's Next?

- ▶ Alter the structure and training methods of the Q-meter network to filter noisy signals from long $\lambda/2$ cables.

What's Next?

- ▶ Alter the structure and training methods of the Q-meter network to filter noisy signals from long $\lambda/2$ cables.
- ▶ Create further networks/expand current ones to work on proton signals.

What's Next?

- ▶ Alter the structure and training methods of the Q-meter network to filter noisy signals from long $\lambda/2$ cables.
- ▶ Create further networks/expand current ones to work on proton signals.
- ▶ Implement trained networks in a laboratory setting to allow signal extraction outside of the Q-Meter's operational parameters.

Thank You For Listening!