

NMR with Machine Learning

Devin Seay, Ishara Fernando,
Dustin Keller



U.S. DEPARTMENT OF
ENERGY

Office of
Science



UNIVERSITY
of VIRGINIA





Outline

- NMR Measurements w/ (Liverpool) Q-Meter
- Deuteron lineshape and simulations
- Why Artificial Neural Networks (ANN)?
- Preliminary results
- Observations & Outlook

What is Nuclear Magnetic Resonance (NMR)?

- Nuclear Magnetic Resonance, or NMR, is the physical phenomenon that occurs when a constant magnetic field is applied to nuclei at resonance which is perturbed by a weak oscillating magnetic field, which causes the nuclei to respond by producing an electromagnetic signal with a frequency characteristic of the magnetic field of the nuclei.
- In the case of this project, we are using NMR to study the inner structure of the Deuterium nucleus (Deuteron).

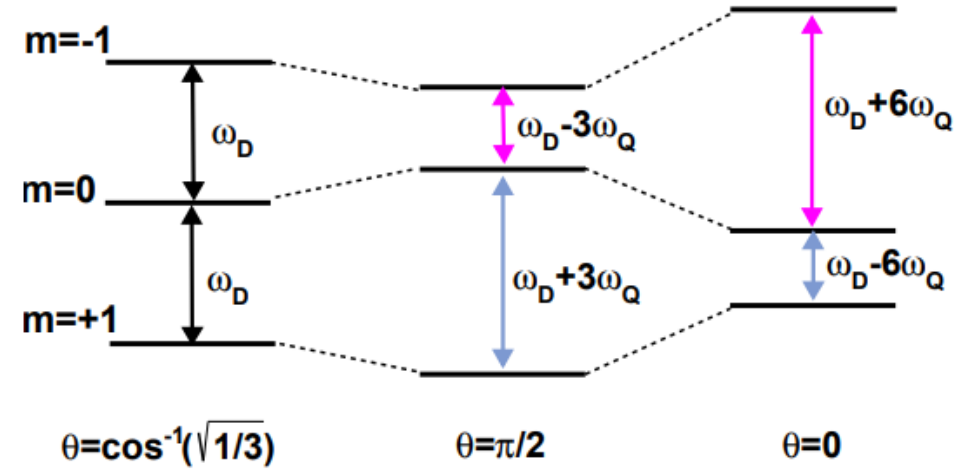

Q-Meter Based NMR

- Using a non-destructive continuous wave phase-sensitive detector (ex., a Q-meter), is required to make accurate measurements of polarization in scattering experiments

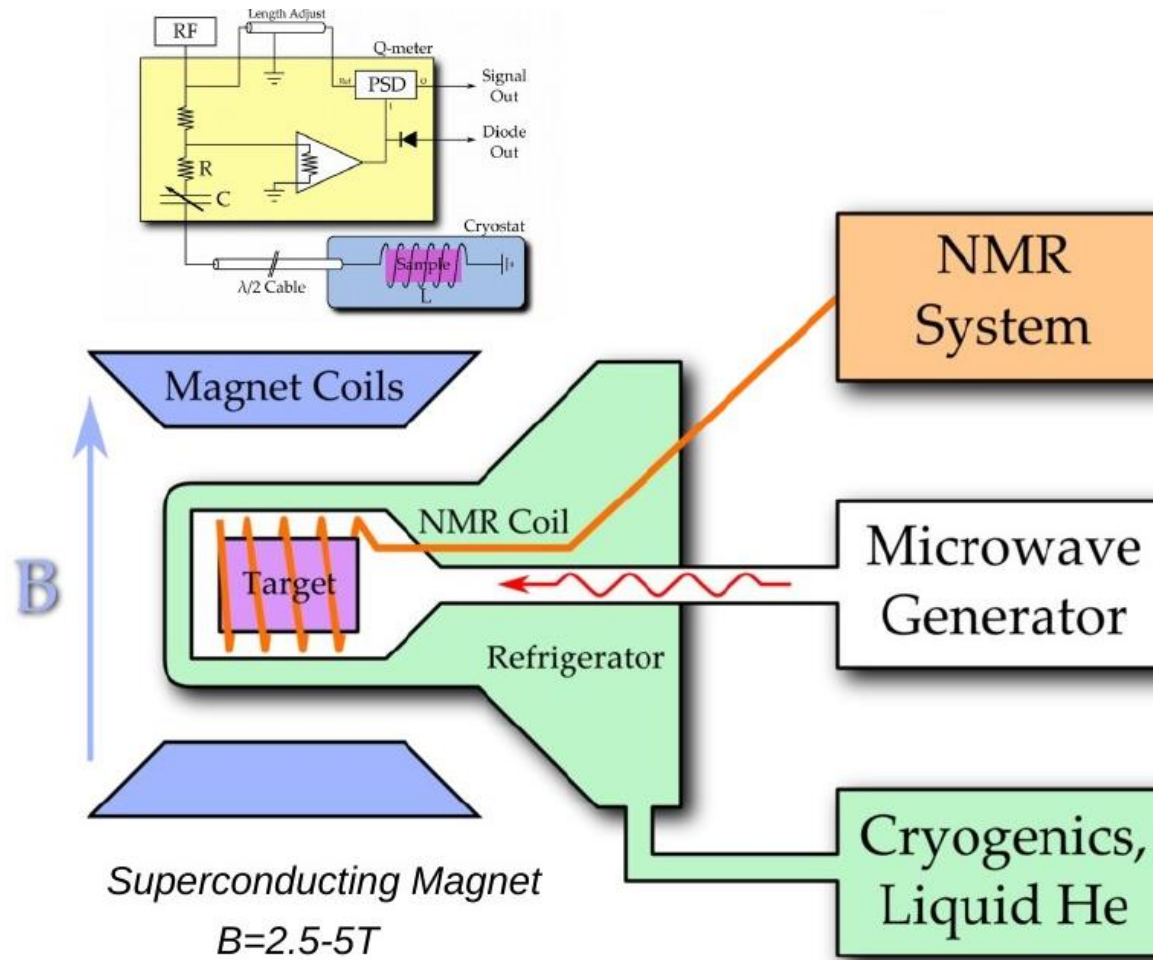

*Polarization
Detection*

*Tuned To Larmor
of spin species
Proton (42.6 MHz/T)*

*Larmor-ESR
50-185 GHz
~140 GHz at 5T*

T=0.03-1K

NMR Measurements with Q-Meter

General System

- Q-meter couples to the magnetic susceptibility of target material (e.g. Solid Ammonia)
 - Signal passes through $\lambda/2$ length cable (358.0 cm for 5T), so the continuous wave NMR signal has a tuning range of $\lambda/2$ to $7\lambda/2$
 - With a frequency range of 3-300 MHz
- Within these limits, we expect a linear relationship between Polarization and scale (ideal settings gives 2% relative error)

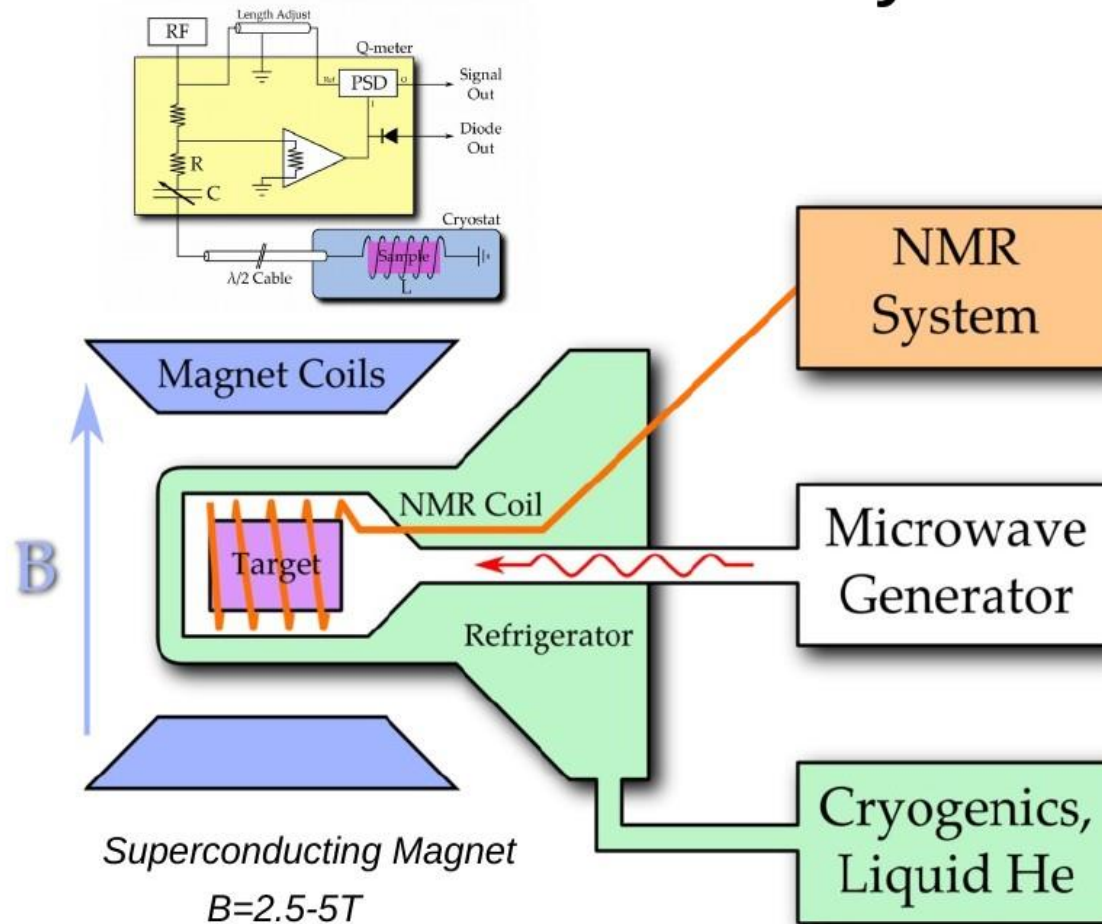

Polarization Detection

*Tuned To Larmor of spin species
Proton (42.6 MHz/T)*

*Larmor-ESR
50-185 GHz
~140 GHz at 5T*

T=0.03-1K

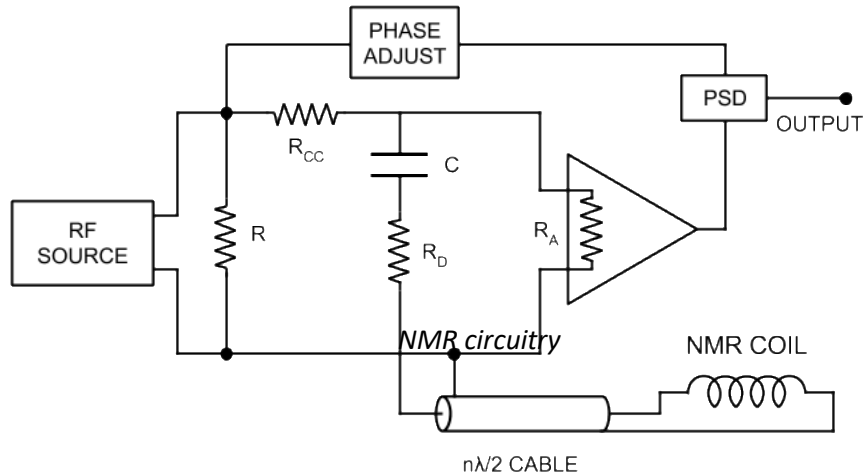
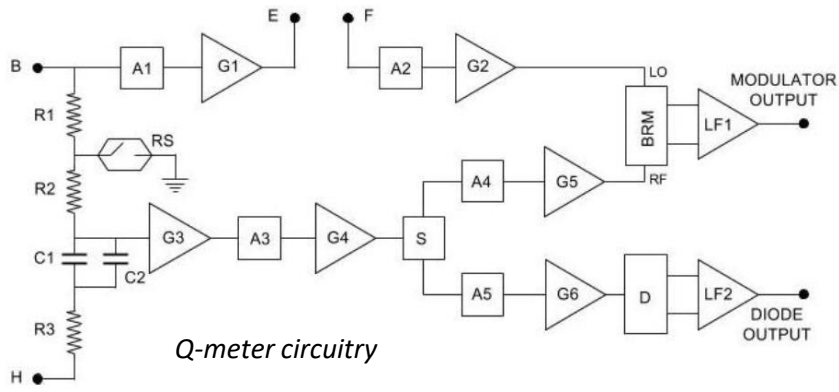
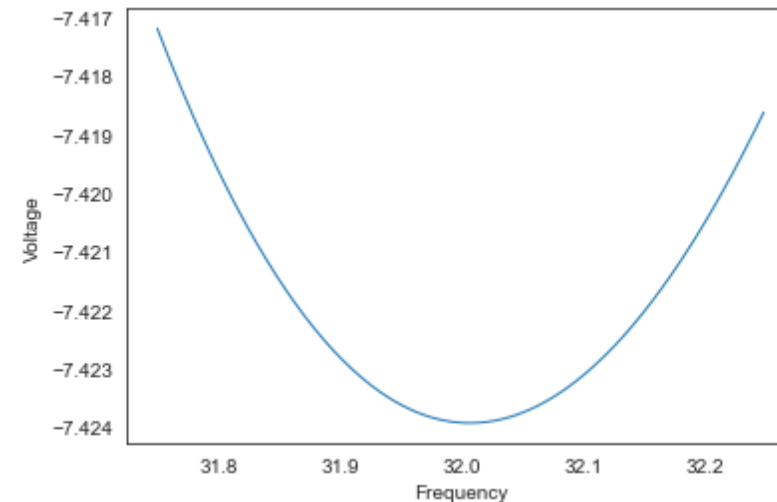

Figure reference: Nuclear Instruments and Methods in Physics Research A324 (1993)

Q-Meter Design

- Q-meter parameters:

- U , the input voltage (V), calculating using: $V(\omega) = IZ(\omega)e^{i\phi(\omega)}$
- C_{knob} , the tuning capacitance
- $n/2$, the trim, is the half-integer length of the $\lambda/2$ such that each full-length segment of a cable is $n\lambda/2$
- η , the filling factor of the coil, is the level of coupling of spins in the target material to the sampling coil
- ϕ , the phase offset, expressed in the form: $\phi(\omega) = a\omega^2 + b\omega + \phi$
- C_{stray} , is the stray capacitance, including parasitic capacitance
 - True C calculated as $C(\omega) = (20 \cdot 10^{-12}) * C_{knob}$



Q-meter Equations

$$Re(u_i) = \frac{U}{R_0} \frac{Re(Z) + Y[Re^2(Z) + Im^2(Z)]}{[(1 + Y Re(Z))^2 + Y^2 Im^2(Z)]}$$

$$Z_T = R_D = \frac{1}{i\omega C} + Z_C \frac{Z_L + Z_C \tanh(\gamma l)}{Z_C + Z_L \tanh(\gamma l)}$$

$$Z_C(\omega) = 1/(i\omega C(\omega))$$

$$Y = 1/R_i + 1/R_0$$

$$Z(\omega) = \frac{R_1}{1 + \frac{R_1}{r + Z_C(\omega + Z_T(\omega))}}$$

$$\phi(\omega) = \phi_{trim}(\omega) + \phi_{const}$$

$$V_{out}(\omega) = -IZ_{total}(\omega)e^{i\phi(\omega)\frac{\pi}{180}}$$

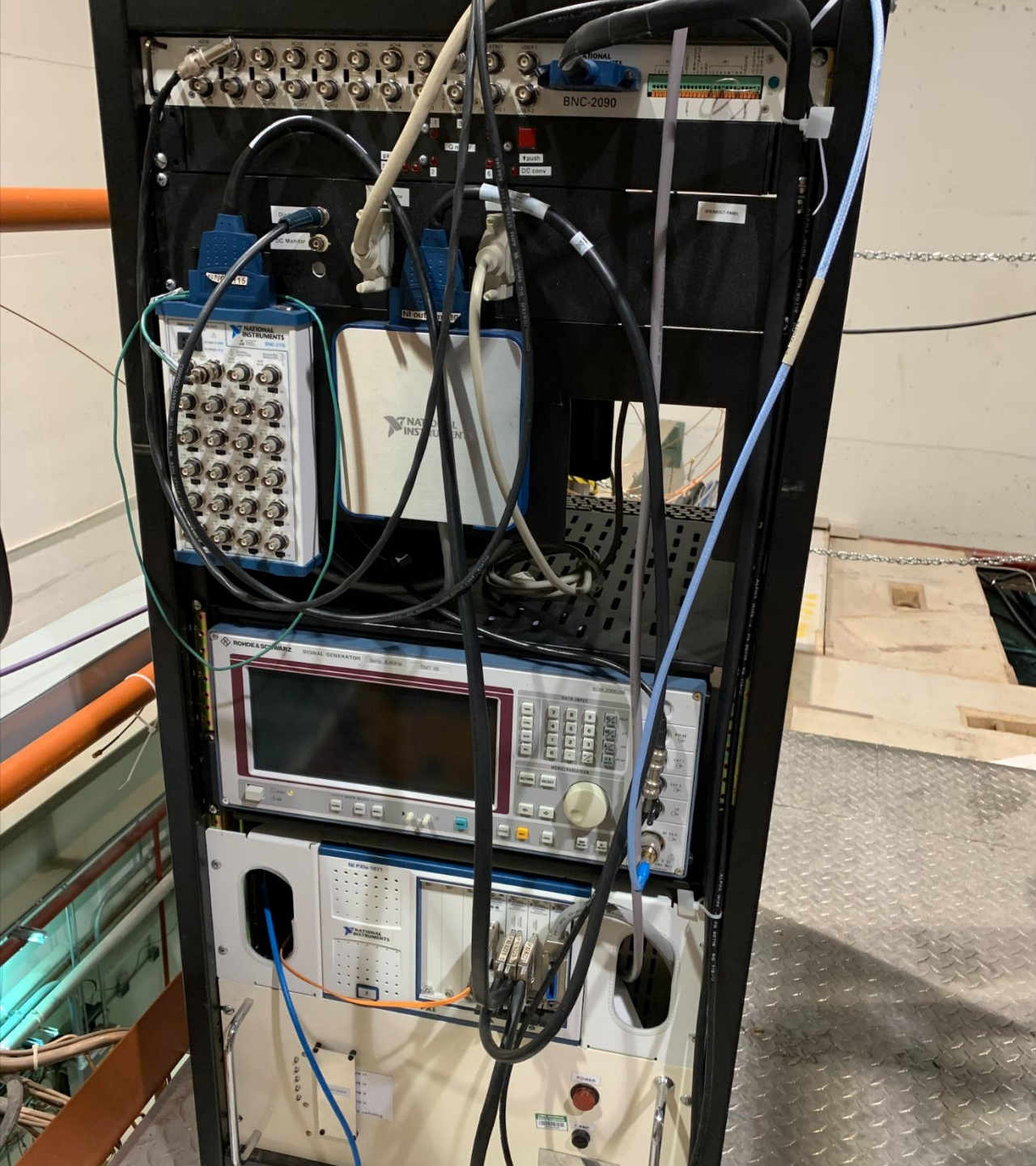

NMR System

Deuteron Lineshape

- The Deuteron lineshape has two corresponding absorption lines, I_+ and I_- , which are associated with the analytical function for $\epsilon = \pm 1$
 - These absorption lines arise due to the interaction of the Deuteron's quadrupole moment with the electric field gradient (EFG), which creates non-degenerate eigen states in the energy levels.
 - Because ND3 lacks cubic symmetry, the previously mentioned interaction breaks degeneracy of energy transitions \rightarrow quadrupole splitting leading to two overlapping absorption lines in the NMR spectra (Pake Doublet).
 - The intensity of the signal, and thus the polarization, is a function of the angle θ between the EFG and the holding field.
 - This Pake doublet is particular to spin-1 material without cubic symmetry (Deuteron, Butanol). With it, such as in LiD, we obtain a Gaussian-like lineshape

$$P = \mathcal{K} \int \frac{\omega_d S(\omega)}{\omega} d\omega,$$

$$P = (r^2 - 1)/(r^2 + r + 1)$$

$$r = I_+/I_-$$

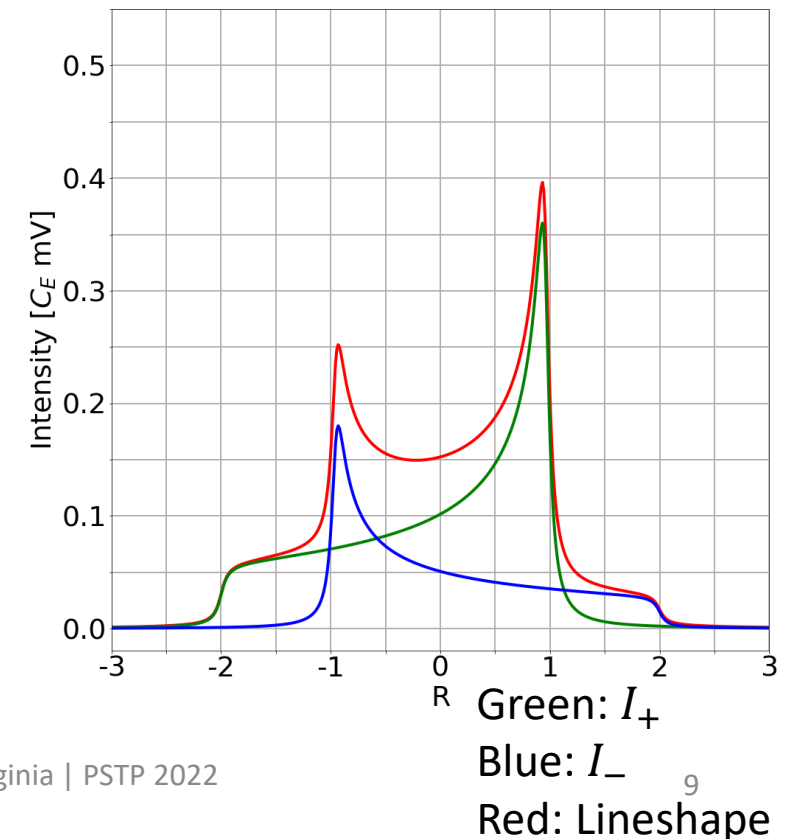

Deuteron Lineshape

- The Pake Doublet is mathematically described by the energy levels:

$$E_m = -\hbar\omega_D m + \hbar\omega_Q (3\cos^2\theta - 1 + \eta\sin^2\theta\cos 2\phi)(3m^2 - 2)$$

- The peaks correspond to the principal axis of the coupling interaction being perpendicular ($\theta = \pi/2$) to the magnetic field.
- The opposing end (the pedestal) corresponds to the configuration when the principal axis of the coupling interaction is parallel ($\theta = 0$) to the magnetic field

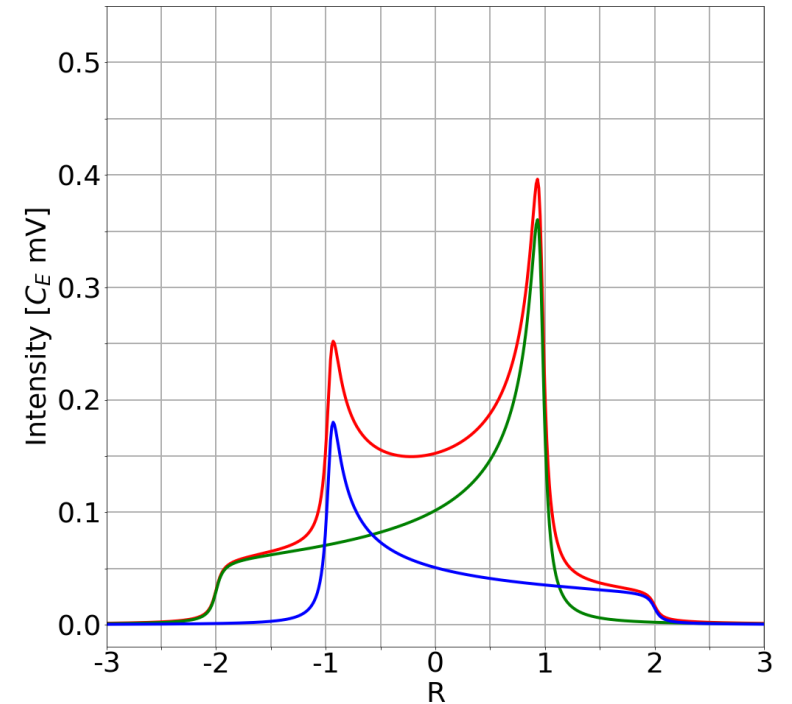

Green: I_+
 Blue: I_-
 Red: Lineshape

$$\mathcal{F} = \frac{1}{2\pi\mathcal{X}} \left[2\cos(\alpha/2) \left(\arctan\left(\frac{\mathcal{Y}^2 - \mathcal{X}^2}{2\mathcal{Y}\mathcal{X}\sin(\alpha/2)}\right) + \frac{\pi}{2} \right) \right. \\ \left. + \sin(\alpha/2) \ln\left(\frac{\mathcal{Y}^2 + \mathcal{X}^2 + 2\mathcal{Y}\mathcal{X}\cos(\alpha/2)}{\mathcal{Y}^2 + \mathcal{X}^2 - 2\mathcal{Y}\mathcal{X}\cos(\alpha/2)}\right) \right],$$

$$\mathcal{Y} = \sqrt{3 - \eta\cos 2\phi}$$

$$\mathcal{X}^2 = \sqrt{\Gamma^2 + (1 - \epsilon R - \eta\cos 2\phi)^2}$$

$$\eta\cos 2\phi \sim 0.04$$

$$\Gamma \sim 0.05$$

$$\cos \alpha = (1 - \epsilon R - \eta\cos 2\phi) / \mathcal{X}^2$$

Real Example of Deuteron Signal

$$P_{TE} = \frac{4}{3} \tanh(\hbar\omega_d/2kT)$$

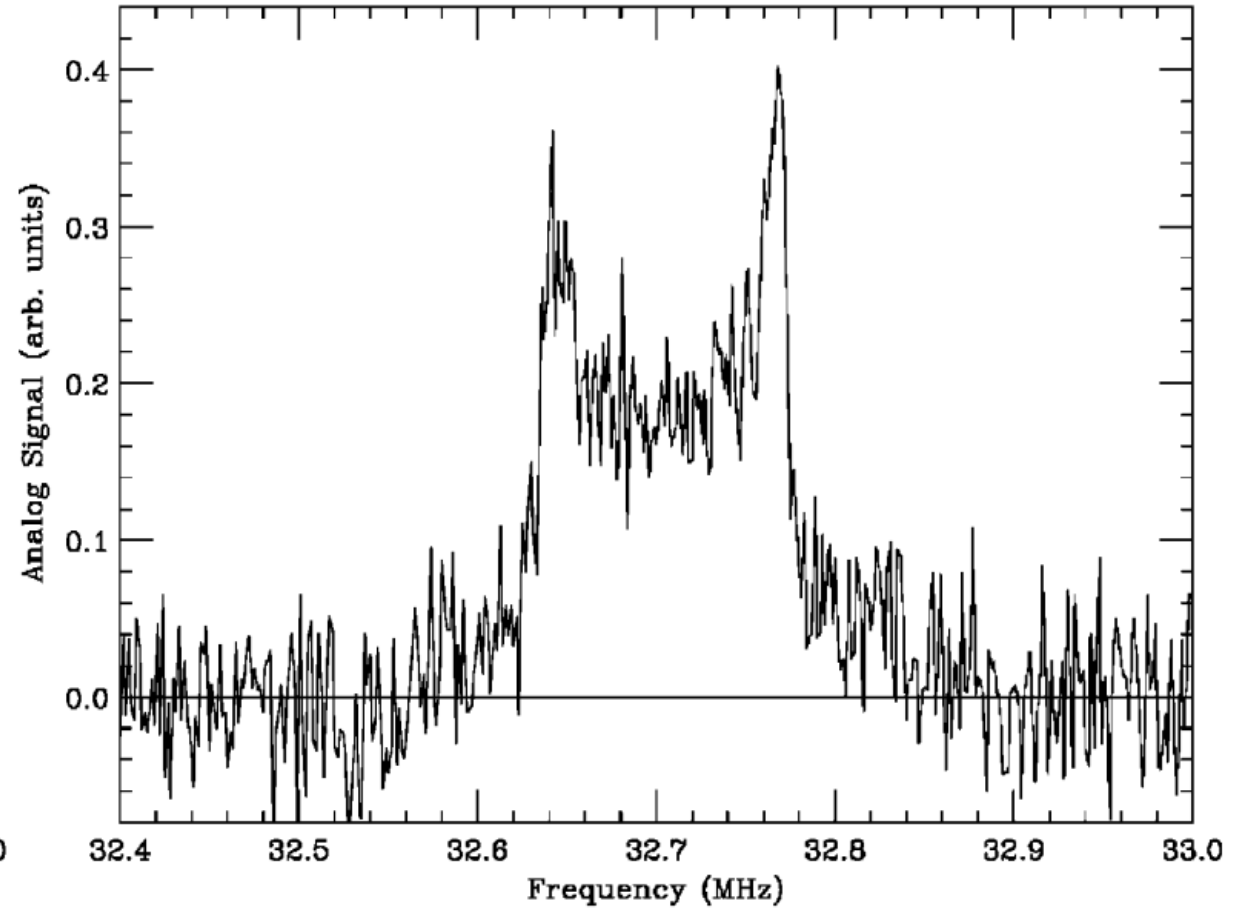
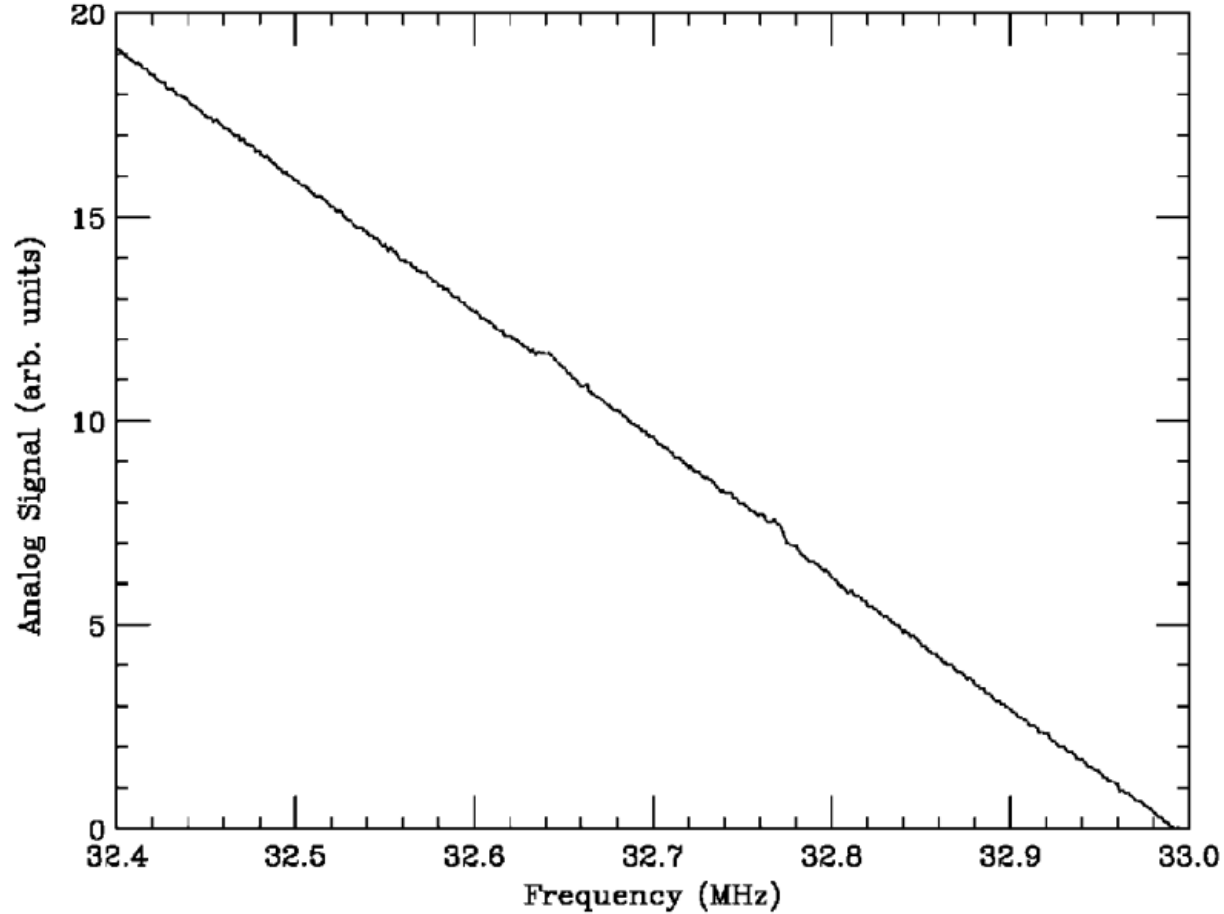

Court, G.R. & Houlden, Michael & Bültmann, S. & Crabb, D.G. & Day, Day & Prok, Y.A. & Penttila, S.I. & Keith, Christopher. (2004). High precision measurement of the polarization in solid state polarized targets using NMR. Nuclear Instruments and Methods in Physics Research Section A: Accelerators, Spectrometers, Detectors and Associated Equipment. 527. 253-263. 10.1016/j.nima.2004.02.041.

Measuring Polarization

- Thermal Equilibrium (Previous technique)
 - When we have the lattice (L-Helium) and the target material at the same temperature, we can obtain the TE polarization by the equation:
 - $P_{TE} = \frac{4}{3} \tanh(\hbar\omega_d/2kT)$
 - Then for any polarization not in TE
 - $P = C \times P_{TE}$, where C is the calibration constant calculated
- Using TE method comes with considerable error (~ 7% relative error) from the change in area of the TE signal and the fitted signal.

Limitations for Deuteron polarization determination

- The Liverpool Q-meter system allows for relative accuracy a deuteron signal's polarization (error of about 1%). However, in the experimental setting, this is far worse, especially at low polarizations. Normally in the experimental setting, we'd expect a relative uncertainty of about 4-6%
- Sources of error:
 - $n\lambda/2$ cable length (Deuteron's small magnetic moment can lead to large Q-curves)
 - Q-meter configurations (calibration constant)
 - Changes in Radiofrequency (RF) environment
 - Temperature Change
 - Statistical errors dependent on DAQ
- Here, we're concerned with trying to overcome complications caused by the first and third sources



Why Artificial Neural Networks (ANN)?

What is ANN?



Neural networks learn (or are trained) by processing examples, each of which contains a known "input" and "result," forming probability-weighted associations between the two, which are stored within the data structure of the net itself.



The training of a neural network from a given example is usually conducted by determining the difference between the processed output of the network (often a prediction) and a target output. This difference is the error.



The network then adjusts its weighted associations according to a learning rule and using this error value. Successive adjustments will cause the neural network to produce output which is increasingly like the target output.

Benefits of ANN in NMR

ALLOWS US TO OPERATE OUTSIDE
THE Q-METER DESIGN PARAMETERS
AND ACCURATELY EXTRACT
POLARIZATION MEASUREMENTS
(AROUND 1-2% RELATIVE ERROR)

EVEN WITH ADDED GAUSSIAN NOISE
TO MAKE THE DEUTERON SIGNAL
LESS DISCERNABLE, ANN CAN BE
TRAINED TO FILTER OUT THE NOISE
AND MEASURE THE TRUE
POLARIZATION OF A SIGNAL BY
NOISE THAT HAS AN SNR OF 10 AND
BELOW

Neural Networks: A Possible Solution

- By training a neural network (NN) on sample data that replicates experimentally accurate noise levels that evolve through time, we can go beyond the capability of the Q-meter and make up for where it lacks.
- Using to optimize precision and accuracy, regardless of Signal-to-Noise Ratio (SNR)
- SNR: ratio of maximum of amplitude of signal to maximum of amplitude of noise, represents how overwhelming the noise is
- In our case, we simulate and extract the signal over 500 data bins
- By training an NN to associated a specific polarization with its associated signal over 500 data bins, we can accurately predict polarization for a given noisy signal

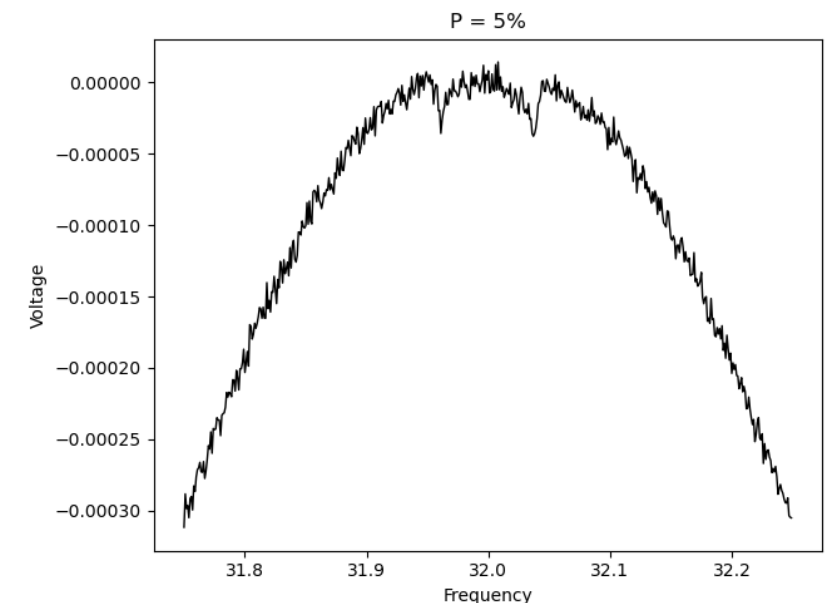
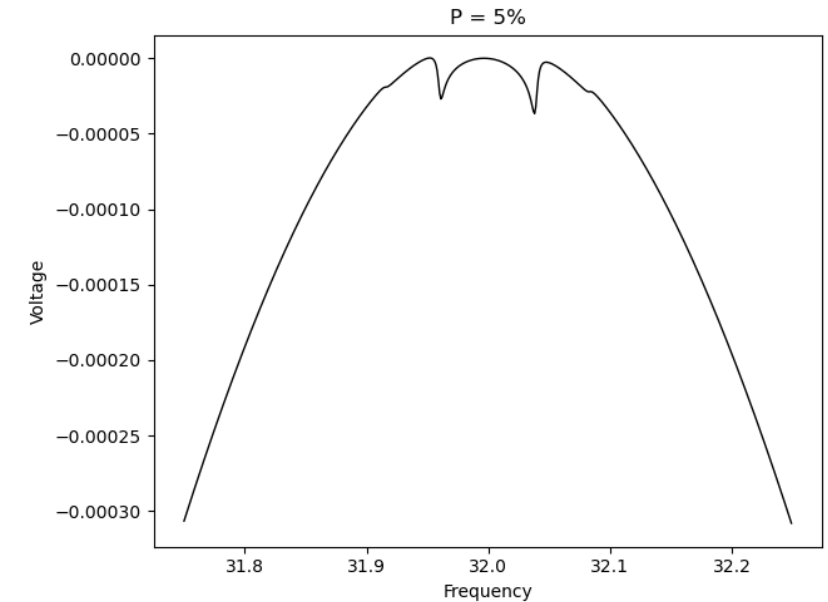

NN Architecture

- Input layer: 500 nodes (each input node is one of 500 frequency bins of a sample signal)
- 5 Hidden layers (varying node sizes)
- Output layer: 1 node → polarization!
- Optimizer used: Adam, a popular optimizer for most general purposes
- Relu6 is used as an activation for layer up until the output layer
 - Sigmoid is used in output layer to return a value between 0 and 1.
- Regularizer L2 is used on each layer
- Trained for 1000 epochs

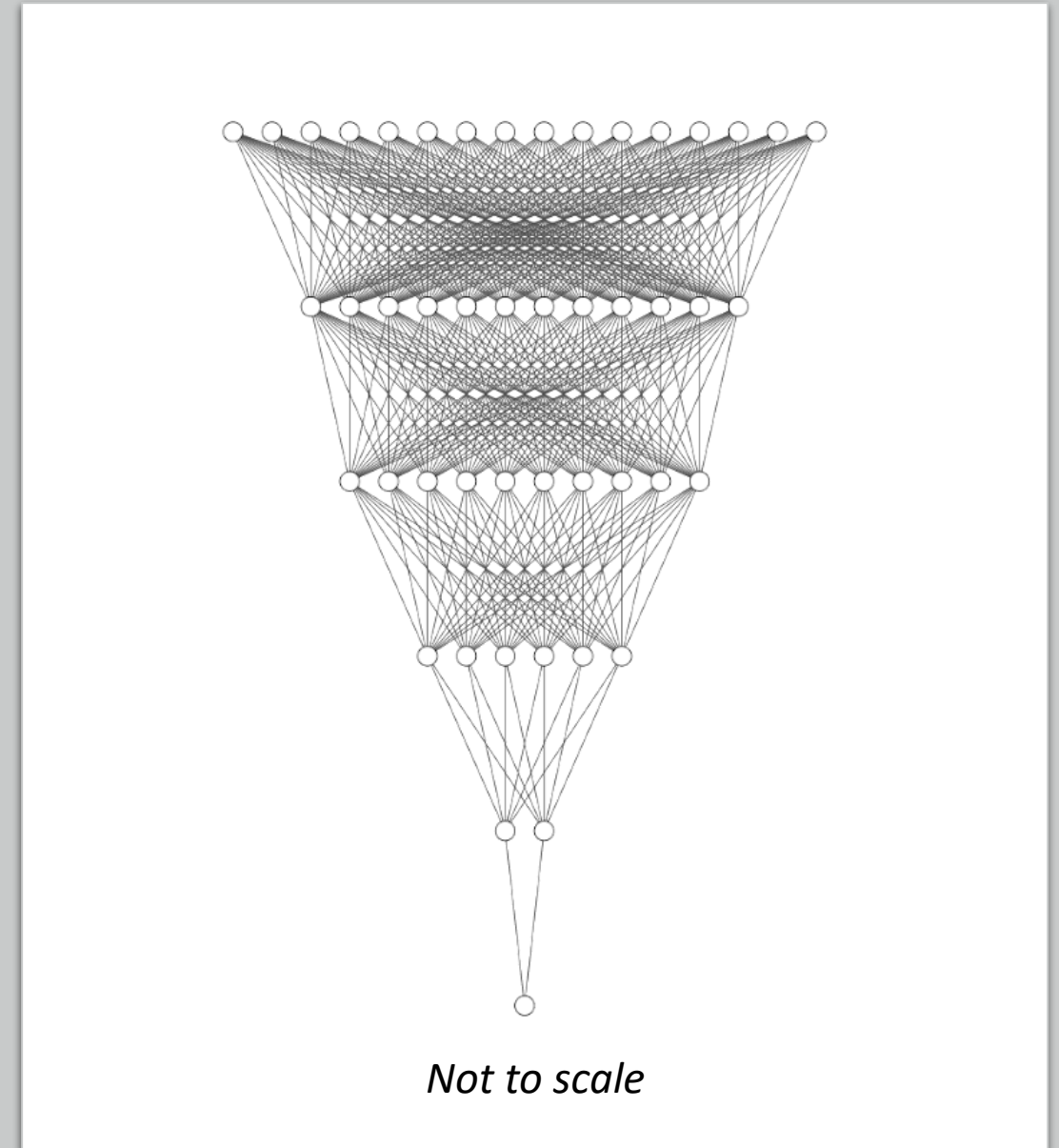

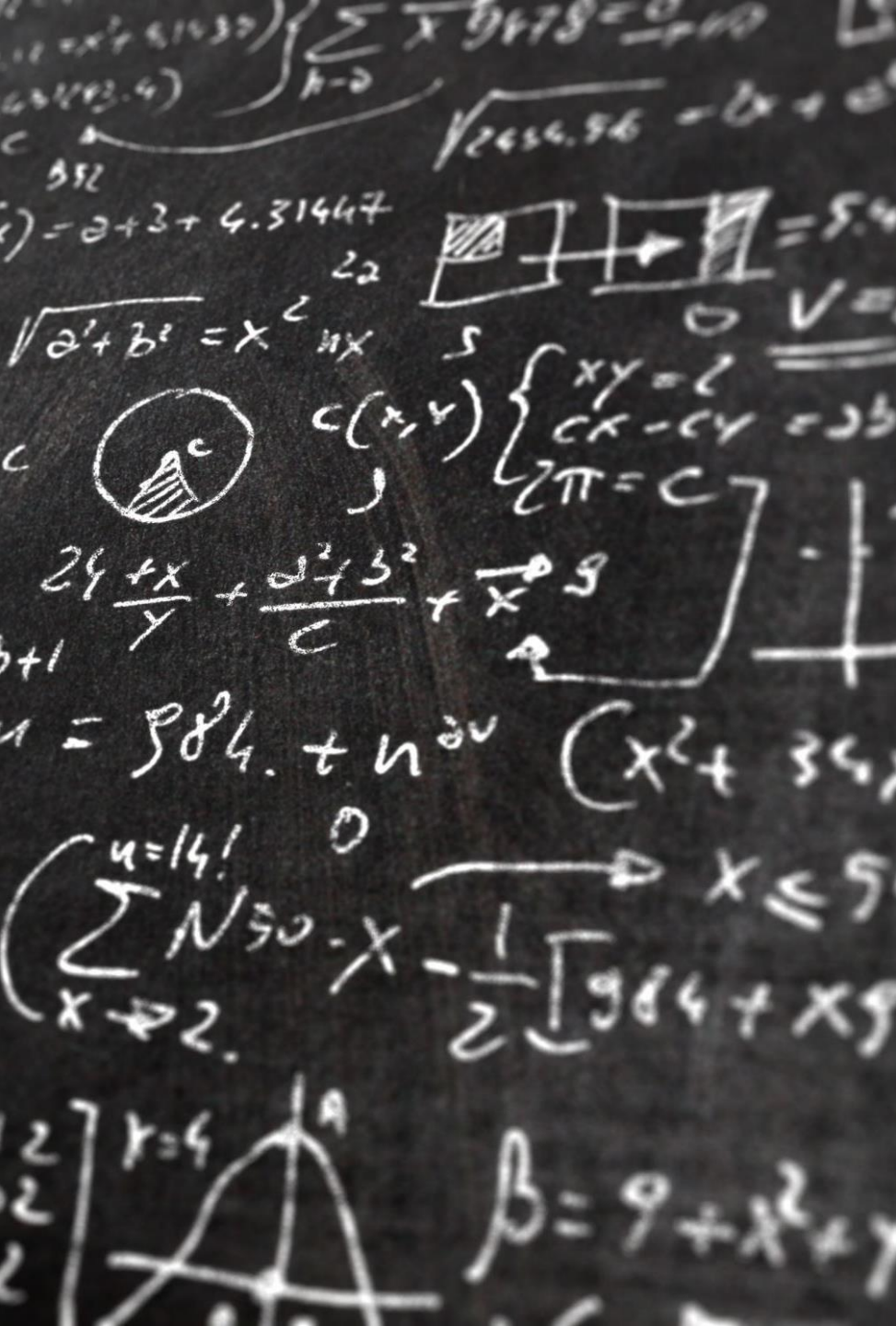

Sample Data Creation

- NN is trained on sample data that varies P from 0-1
 - Noise is generated as a Gaussian distribution with standard deviation
 - Standard deviation is varied from 0 to roughly 10^{-3} , a deviation well above the size of the signal
 - 4 Million events are created to train on

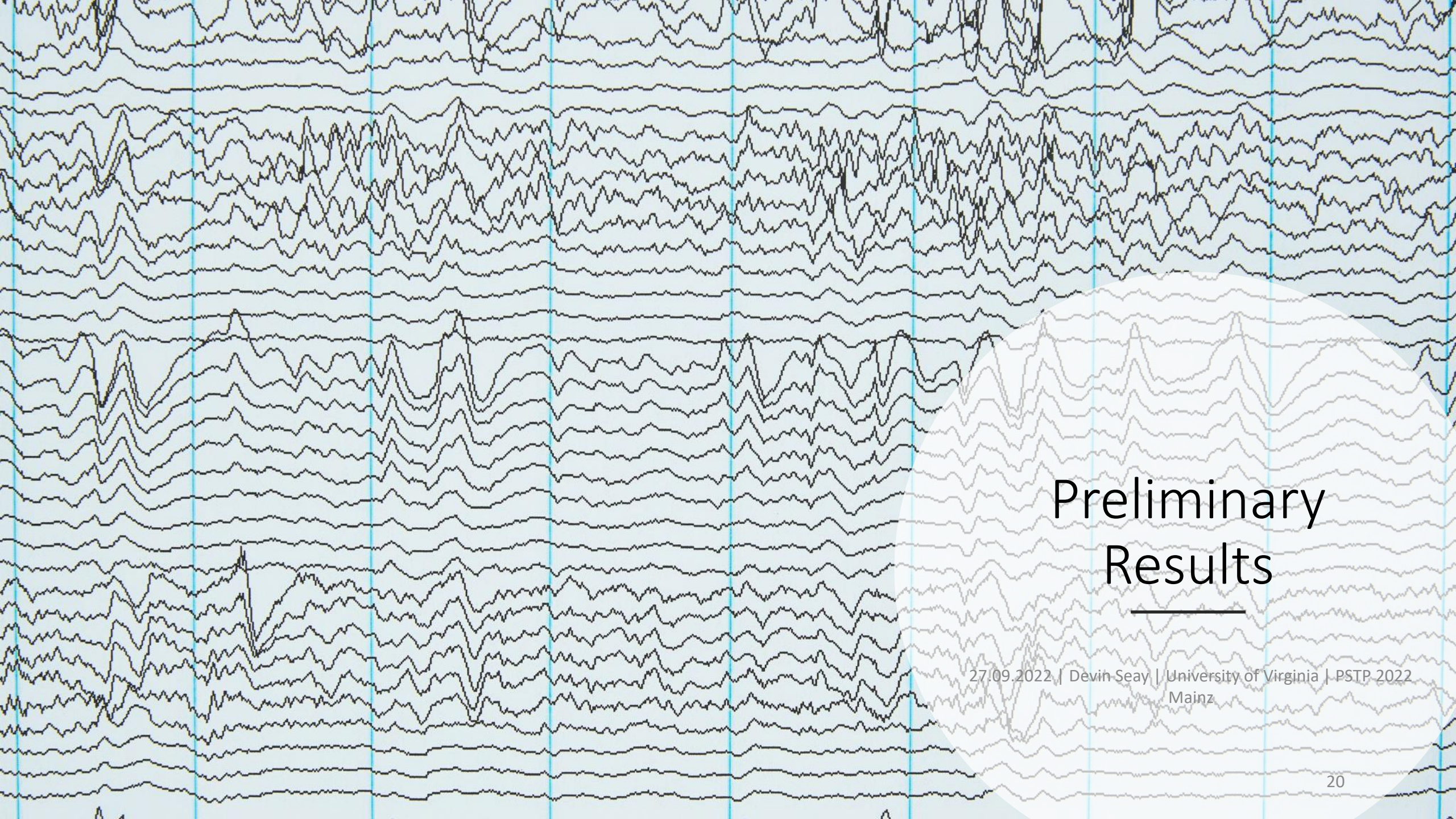

Preliminary Results

27.09.2022 | Devin Seay | University of Virginia | PSTP-2022
Mainz

$$SNR = \frac{|Signal_{Max}|}{|Noise_{Max}|}$$

Training the Neural Network & Preliminary predictions

Sample data is created with noise added for a given cable length n and level of polarization P between 0 and 1. NN is then trained to recognize lineshape of particular P within the noise over 500 epochs

- Histogram of percentage difference (%) predicted by NN for 100K sample events between 0%-100% polarization
- SNR: 15-40
- Accuracy, how close sample data is to true value : 99.835%
- Precision, how much sample data varies from true value: 99.438% (width of predicted P's)

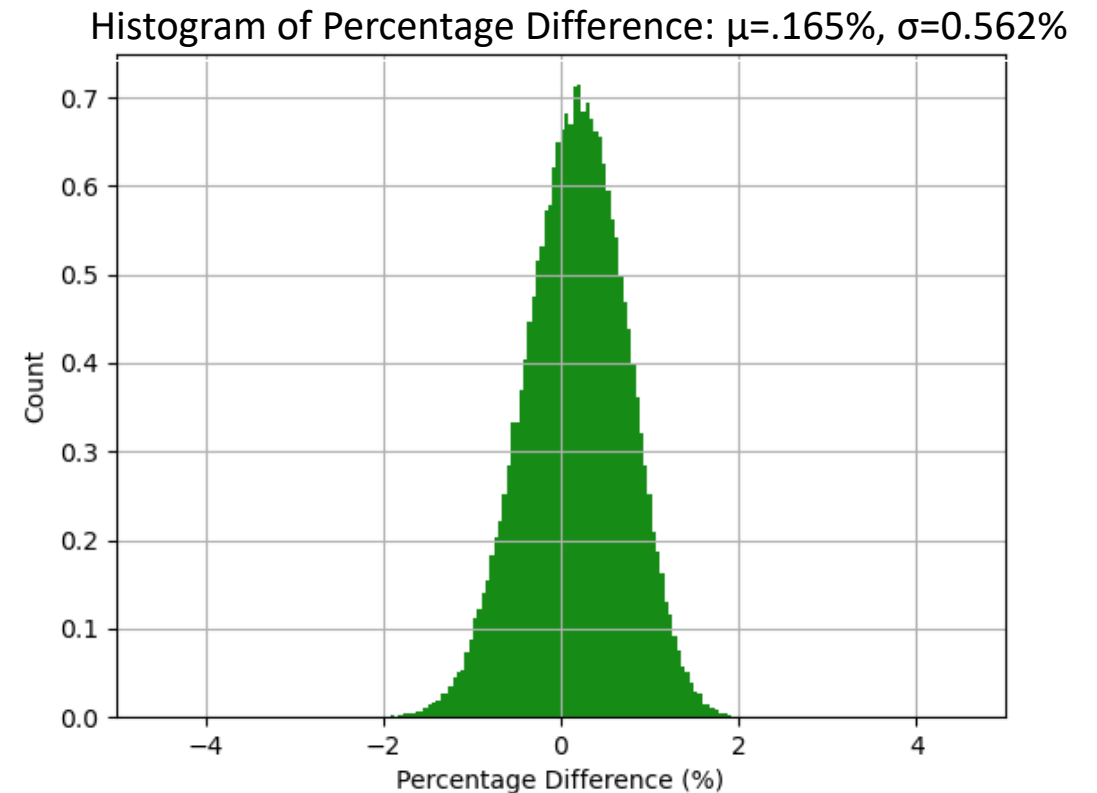

$$P_{Diff} = P_{True} - P_{Predicted}$$

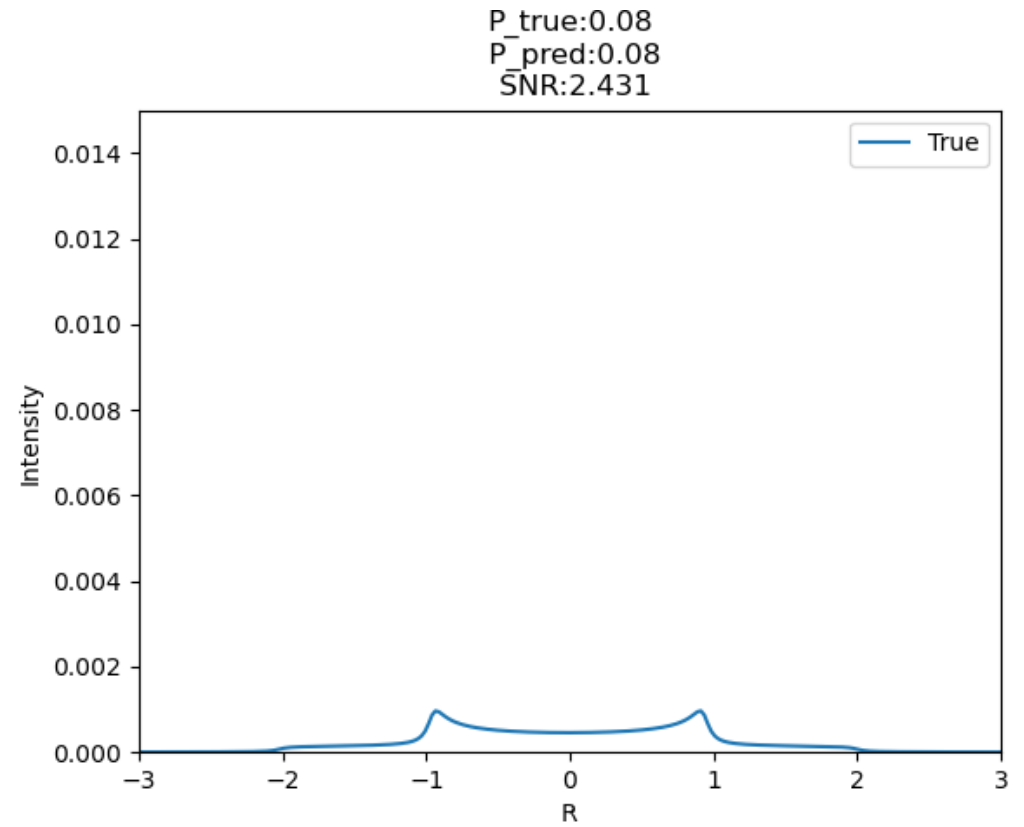
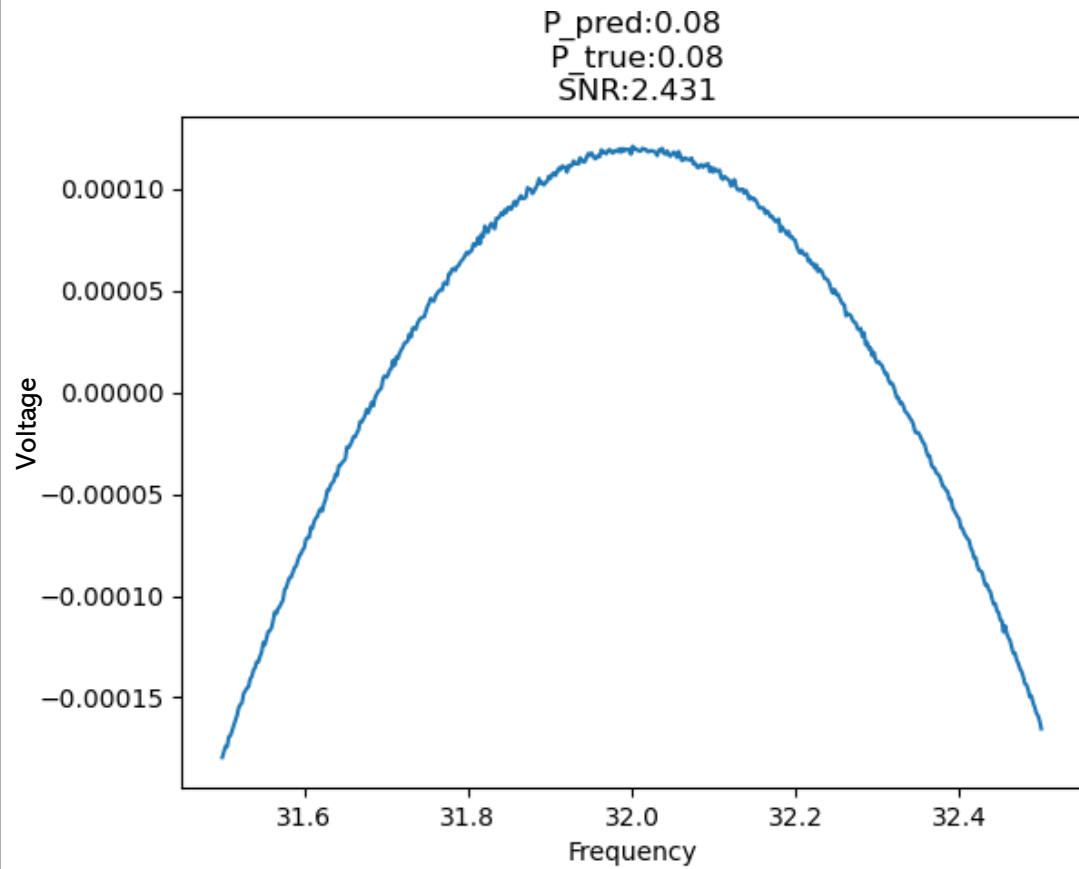

$$R = \frac{\omega_D - \omega}{3\omega_D}$$

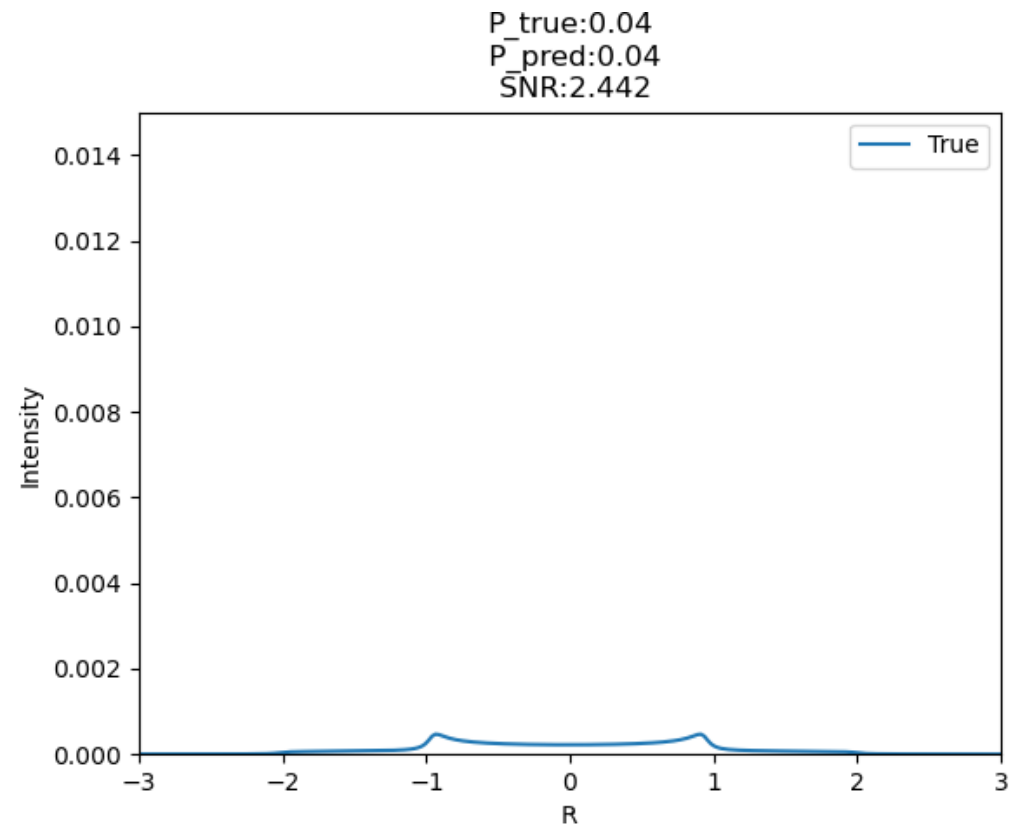
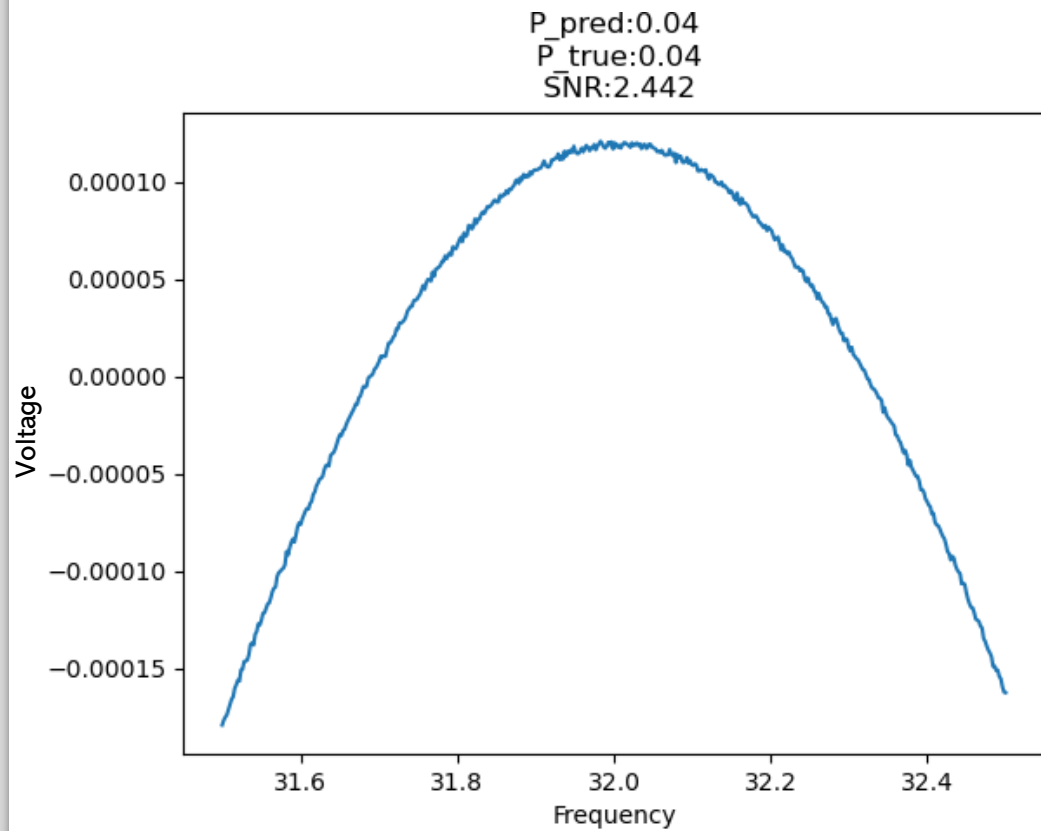

$$R = \frac{\omega_D - \omega}{3\omega_D}$$

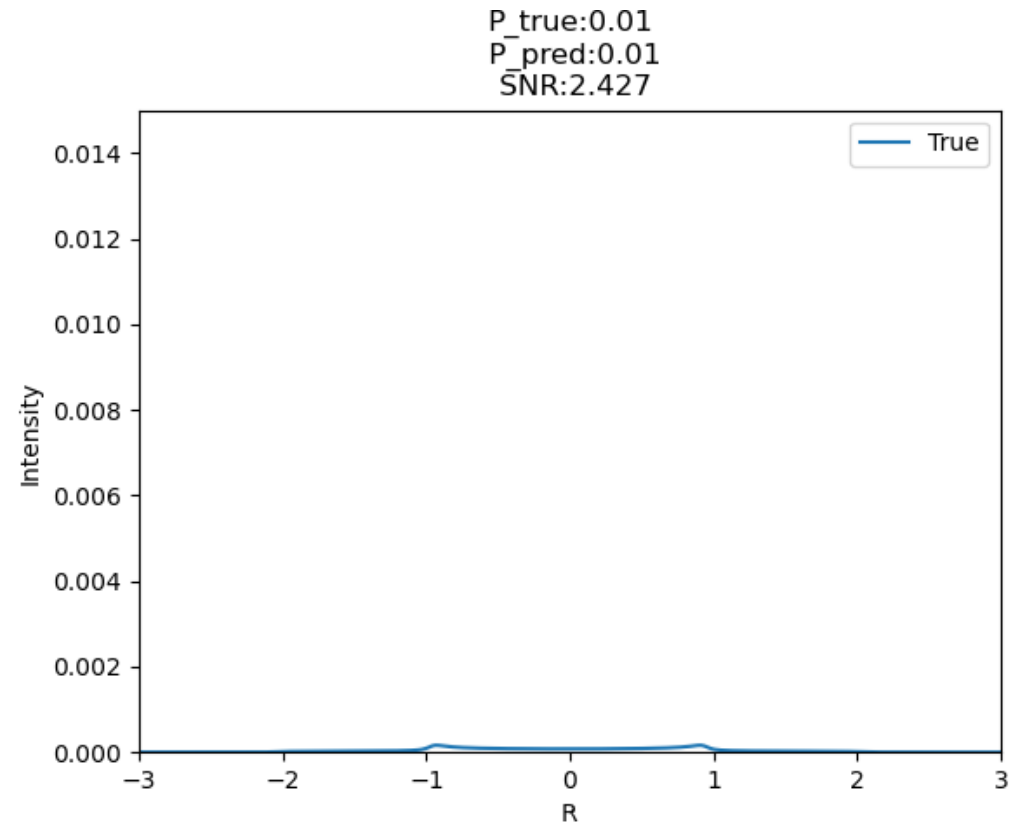
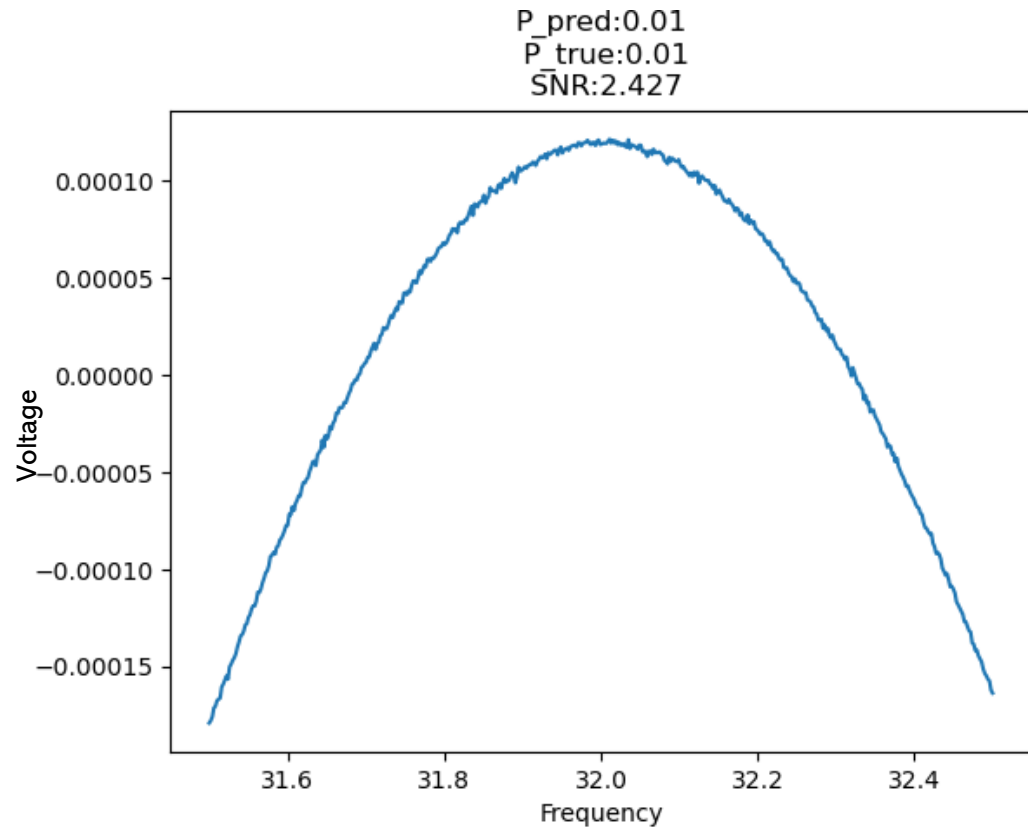

$$R = \frac{\omega_D - \omega}{3\omega_D}$$

Prospective Outlook and Future Plans

ANN can allow for the efficient filtering of background noise from deuteron signal (could also be applied to any NMR signal)

The adaptability of the ANN allows for changes in baseline and scanning range of an NMR to quickly and easily be considered

For the future: optimize the ANN for smaller polarizations to increase precision and accuracy

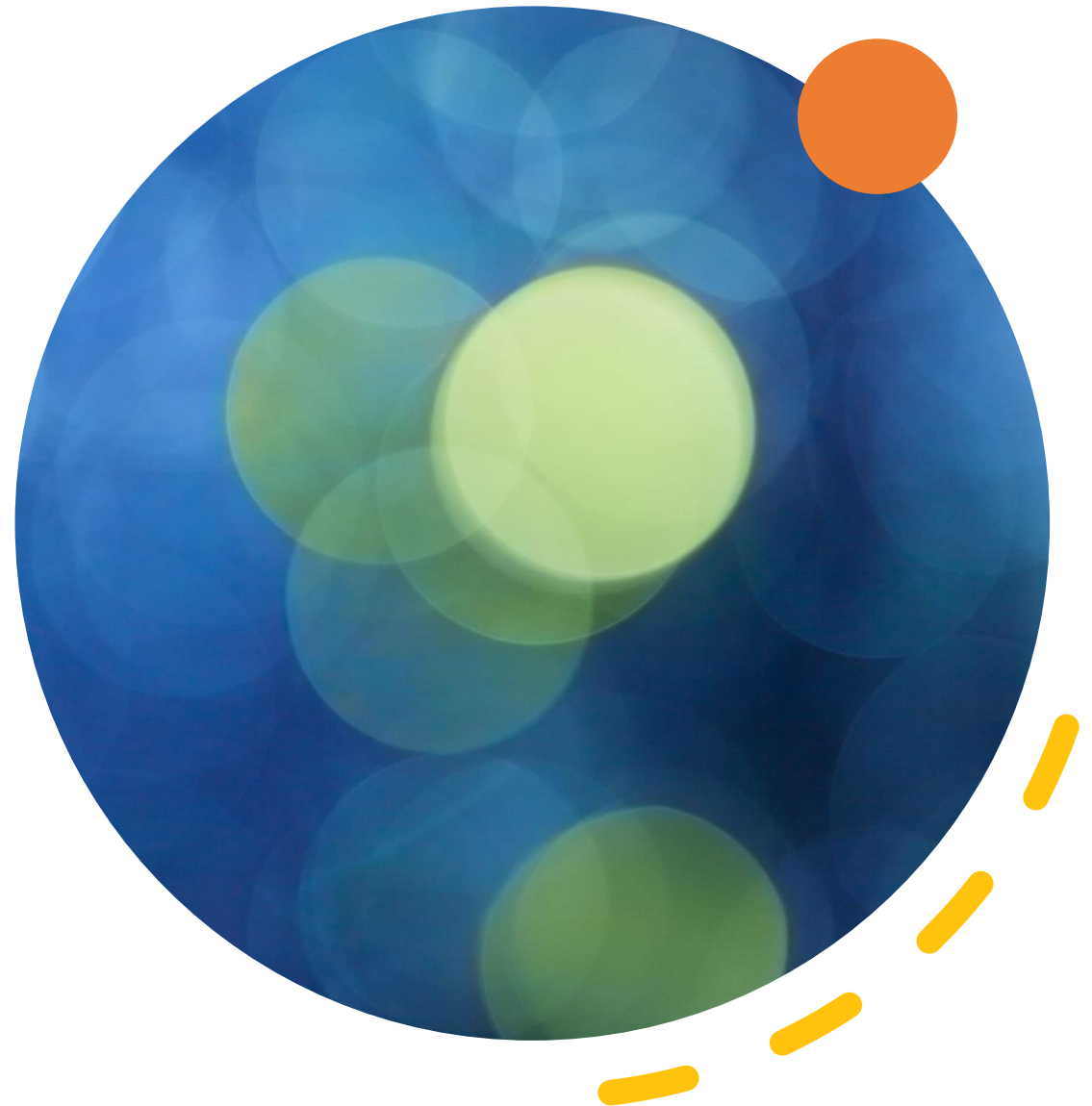



Thank you!

***This work was supported
by DOE contract DE-
FG02-96ER40950***

27.09.2022 | Devin Seay | University of Virginia | PSTP 2022
Mainz